

UNIVERSAL RETRACTOR SETS, LAPAROSCOPIC LIVER RETRACTORS
UNIVERSAL EKARTÖR SETİ, LAPAROSKOPİK KARACİĞER EKARTÖRÜ



All rights reserved.
No visual and text in this catalog can be used without
the written permission of Uzman Cerrahi Aletler.





OUR VISION

Uzman Cerrahi Aletler aspires to become a globally recognized healthcare solutions partner by offering a wide range of products, from top-tier surgical instruments to sterilization containers. With a customer-centric approach, we continuously foster growth by combining innovation and quality, maintaining an international export presence. Our vision is to enhance the well-being of people worldwide by providing high-quality and unique products to the healthcare sector, shaping a better future.

OUR MISION

At Uzman Cerrahi Aletler, we have been continuously growing since 1996, reaching over 75 countries globally, by offering products such as surgical instruments and sterilization containers. We prioritize customer satisfaction, catering to special orders, and producing products that appeal to diverse audiences with our innovative approach. Among our core values are quality, reliability, and sustainability. Our mission is to support human health by providing healthcare professionals with access to the highest standards of surgical instruments and sterilization containers.



NATHANSON STRONGARM™ SYSTEMS

NATHANSON LIVER RETRACTORS AND SYSTEMS

Nathanson-StrongArm Systems all contain an Arm, 3 hooks and 2 scope/instrument tips. **SET NO: 10.550**

Kod: / 5 mm System contains
Açıklama:

10.551	Single Arm StrongArm
10.552	Heavy Duty Rail Clamp
10.553	Small 5 mm Hook
10.554	Med. 5 mm Hook
10.555	Large 5 mm Hook
10.556	SS Instrument Holder
10.557	Delrin Scope Holder

Kod: / 6,5 mm System contains
Açıklama:

10.558	Single Arm StrongArm
10.559	Heavy Duty Rail Clamp
10.560	Small 6,5 mm Hook
10.561	Med. 6,5 mm Hook
10.562	Large 6,5 mm Hook
10.563	SS Instrument Holder
10.564	Delrin Scope Holder

Kod: / 6,5 mm XL System contains
Açıklama:

10.565	Single Arm StrongArm
10.566	Heavy Duty Rail Clamp
10.567	Small 6,5 mm Hook
10.568	Med. 6,5 mm Hook
10.569	Large 6,5 mm Hook
10.570	SS Instrument Holder
10.571	Delrin Scope Holder



FLEXARM™ SURGICAL HOLDERS AND POSITIONERS

UNIVERSAL SYSTEM COMPONENTS EXPAND – REPLACE – UPGRADE

• COMPANION ARMS FOR UNIVERSAL FLEXARM SYSTEMS



10.531
Companion Flex Arm Holding and Positioning Device with Quick Disconnect Distal Tip. Fits 1/2" (1.25 cm) to 5/8" (1.6 cm) diameter round bars such as the lower arms on all Mediflex Universal Systems, StrongArm™ Holding and Positioning Devices and Lap Rack Posts.

• POSTS AND RAIL CLAMPS FOR UNIVERSAL FLEXARM SYSTEMS



10.530
Teknocer Rail Clamp aluminium special production

• ARM AND TIP SYSTEMS

Contains:

Kod:	Açıklama:
10.540	Single Arm/Clamp Stainless Steel Tip



Contains:

Kod:	Açıklama:
10.541	Single Arm/Clamp Delrin Tip



• SETS OF HOOKS



5mm Hook Set Contains 1 each of:

Kod:	Açıklama:
	Small
	Medium
	Large

STRONGARM™ SURGICAL HOLDERS AND POSITIONERS

THE ULTIMATE IN ADJUSTABLE RIGIDITY

10.600

The Twin Arm StrongArm system illustrates the use of the Quick Disconnect System to hold both a laparoscope and a Nathanson Hook. Using a system like this often frees up a surgical tech and allows better utilization of human resources.



UNLOCKED



LOCKED



**LOCKED WITH
TIP INSERT**



Shown here is the small, 6.5 mm Nathanson Hook

ÇATI ELEMENLARI

ROOF TOOLS



Kod: 10.601
Açıklama: 50 cm
Tek bağlantılı çatı mili
Cross bar with single cam joint



Kod: 10.602
Açıklama: 60 cm
Çift bağlantılı çatı mili
Cross bar with 2 cam joints



Kod: 10.603
Açıklama: 13x15 cm
10.604 30x30 cm
10.605 20x40 cm
10.606 20x30 cm
10.607 25x25 cm
10.608 15x50 cm
Açılı çatı mili
Angled cross bar



Kod: 10.609
Açıklama: 30 cm
10.610 40 cm
10.611 50 cm
Düz çatı mili
Straight arm



Kod: 10.612
Açıklama: 50x50x30x30 cm
Katlanabilir eklemlerli çatı mili
Blilateral cross bar



Kod: 10.613
Açıklama: 45 cm
50 cm
Masa bağlantı ayağı / Tek bağlantı
Rail clamp with cam joint

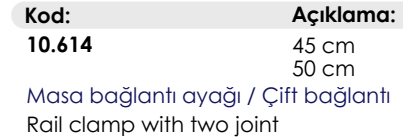

Kod: 10.614
Açıklama: 45 cm
50 cm
Masa bağlantı ayağı / Çift bağlantı
Rail clamp with two joint



Kod: 10.615
Açıklama: 30x30 cm
Katlanabilir tek eklemlerli çatı milleri
Hinged extension arm



Kod: 10.616
Açıklama: 28x21x28 cm
10.617 35x25x35 cm
Katlanabilir çift eklemlerli çatı milleri
Blilateral cross bar



BAĞLANTI ELEMANLARI

CONECTION TOOLS



Kod: 10.618 **Açıklama:** 25 cm

Ekartör Kolu / Açısı ayarlanabilir
Retractor arm, adjustable angle



Kod: 10.619 **Açıklama:** -

Ekartör tutucu / Bükülebilir
Retractor holder flexible



Kod: 10.620 **Açıklama:** 25 cm

Ekartör kolu, Bağlantı elemanı, Açısı ayarlanabilir
Retractor arm with cam joint adjustable angle



Kod: 10.621 **Açıklama:** 25 cm

Ekartör Kolu
Retractor arm

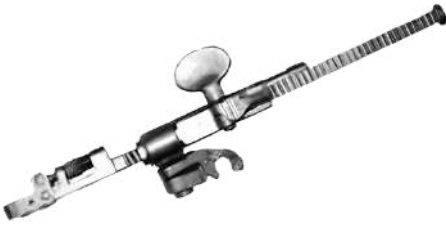

Kod: 10.622 **Açıklama:** 25,5 cm

Ekartör kolu, Bağlantı elemanı, Açısı ayarlanabilir
Retractor arm with cam joint adjustable angle



Kod: 10.623 **Açıklama:** 25 cm

Ekartör kolu bağlantı elemanı
Retractor arm



Açısı ayarlanabilir ekartör kolu
Angle adjustable retractor arm

BAĞLANTI ELEMANLARI

CONNECTION TOOLS



Kod: 10.624 **Açıklama:** 25,5 cm
Ekartör kolu bağlantı elemanı
Retractor arm with cam joint



Kod: 10.625 **Açıklama:** -
Ekartör bağlantı elemanı
Retractor cam joint



Kod: 10.626 **Açıklama:** -
Işık taşıyıcı
Light carrier



Kod: 10.627 **Açıklama:** -
Çağ bağlantı elemanı
Cam frame joint



Kod: 10.628 **Açıklama:** -
Açı değiştirme anahtarı ile kullanılır
Angle change tool

UNIVERSAL EKARTÖR SETİ

MASAYA MONTE UNIVERSAL RETRACTOR SETS

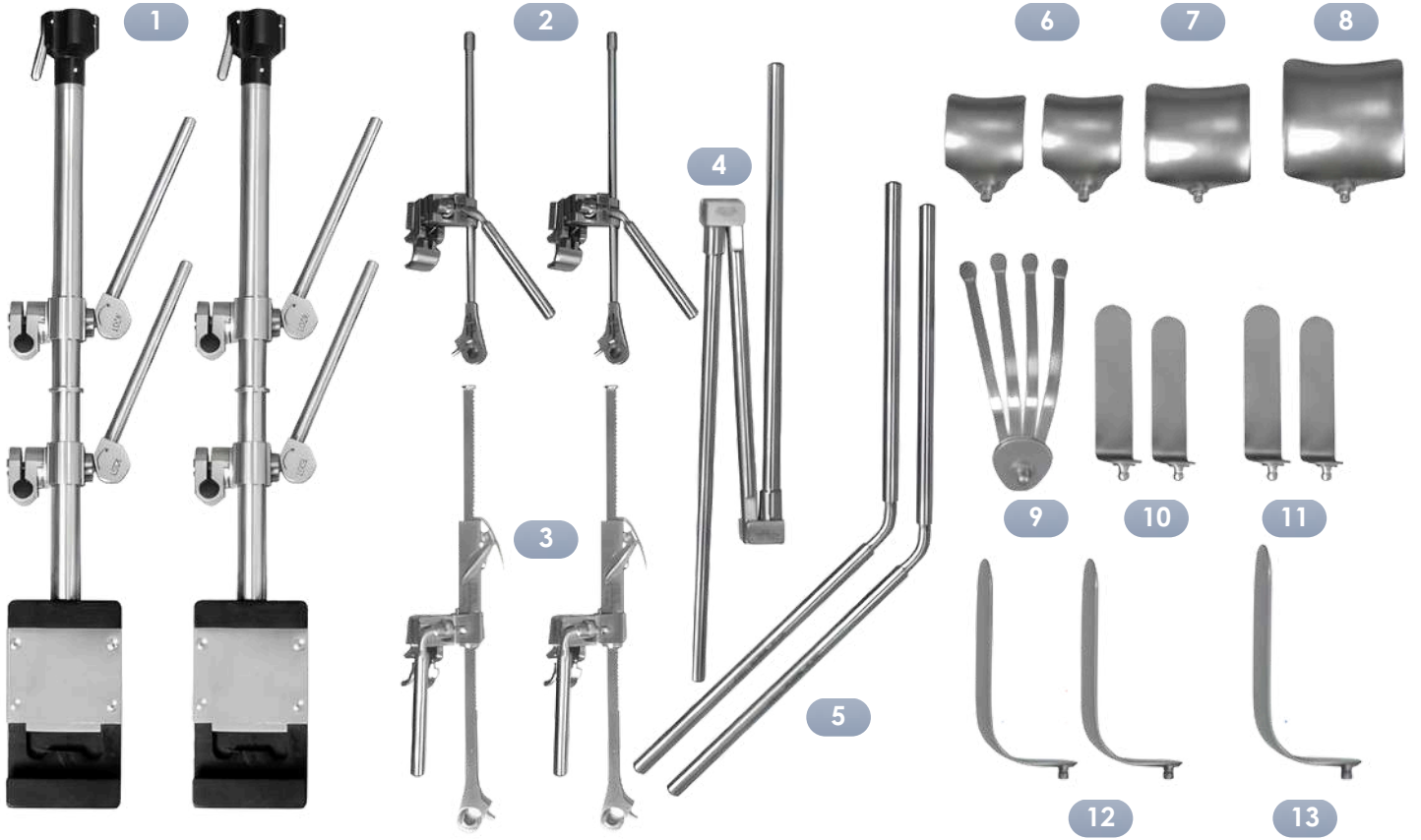

MASAYA MONTE UNİVERSAL EKARTÖR SETİ 10.700

Kod: Açıklama:

1	10.701	Masa bağlantı ayağı çift bağlantılı / 45 cm	2 Adet
2	10.702	Ekartör kolu bağlantı elemanı / 25 cm	2 Adet
3	10.703	Ekartör kolu bağlantı elemanı / 25,5 cm	2 Adet
4	10.704	Katlanabilir çift eklemler çatı mili / 28x21x28 cm	1 Adet
5	10.705	Açılı çatı mili cross bar / 20x40 cm	2 Adet
6	10.706	Balfour bleyt / 70x75 mm	2 Adet
7	10.707	Balfour bleyt / 80x75 mm	1 Adet
8	10.708	Balfour bleyt / 80x125 mm	1 Adet
9	10.709	Bükülebilir bleyt / 150 mm	1 Adet
10	10.710	Deaver bleyt / 40x125 mm	2 Adet
11	10.711	Deaver bleyt / 60x125 mm	2 Adet
12	10.712	Bükülebilir bleyt 50x100 mm	2 Adet
13	10.713	Harrington bleyt / 65x150 mm	1 Adet
*	10.714	Set konteynırı / 580x280x150 mm	1 Adet
*	10.715	Tel sepet / 540x255x100 mm	1 Adet

EKARTÖR SETİ
RETRACTOR SETS

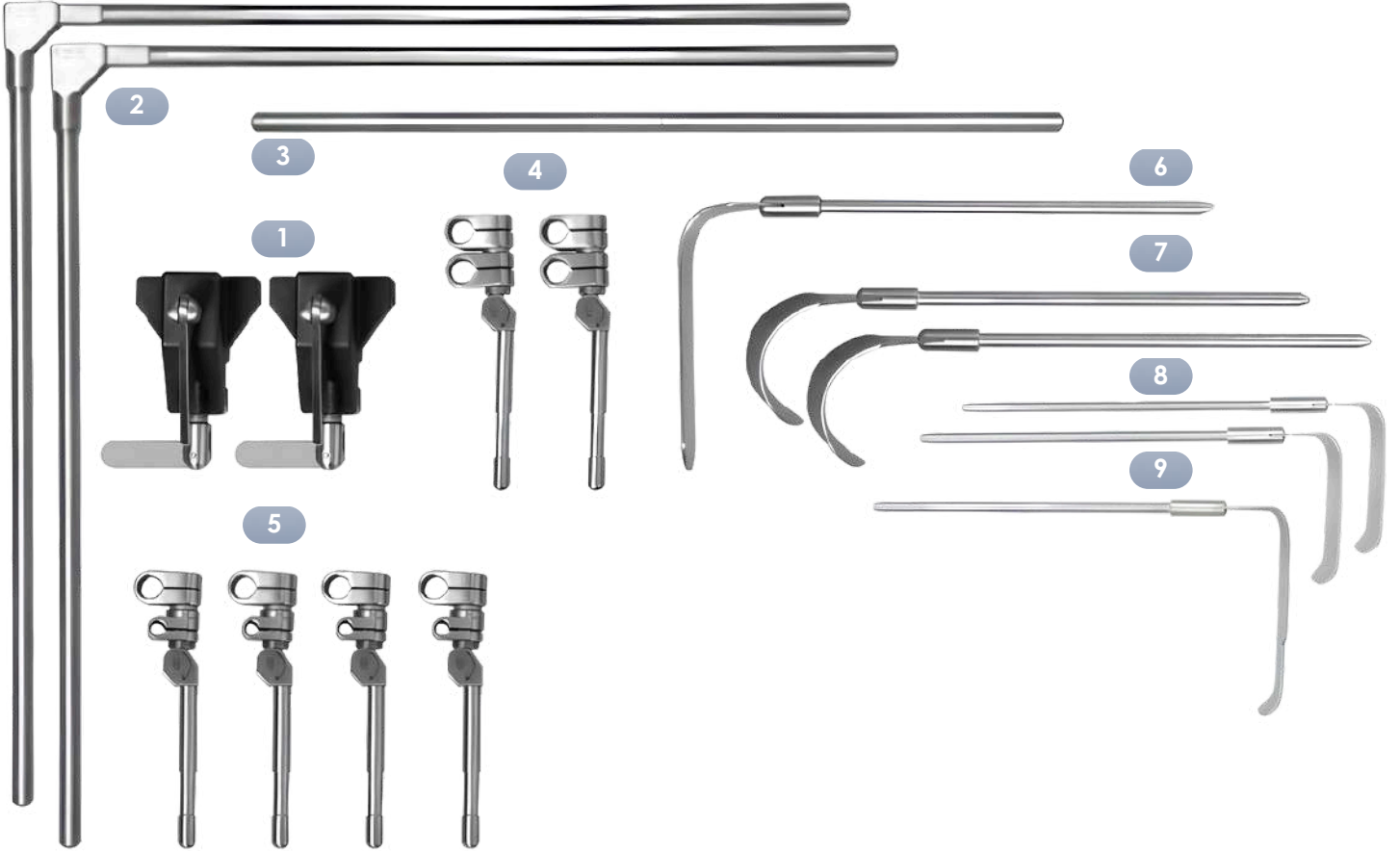

EKARTÖR SETİ 10.750

Kod: Açıklama:

1	10.751	Masa bağlantı mengersi steel	2 Adet
2	10.752	Katlanabilir çatı mili cross bar 50x50 cm	2 Adet
3	10.753	Düz çatı mili 50 cm	1 Adet
4	10.754	Çatı bağlantı elemanı 14x14 mm	2 Adet
5	10.755	Ekartör bağlantı elemanı 8x14 mm	4 Adet
6	10.756	Deaver blade 50x150 mm	1 Adet
7	10.757	Balfour blade 80x75 mm	2 Adet
8	10.758	Richardson blade 50x100 mm	2 Adet
9	10.759	St. Marks Pelvis Ekartörü 65x140 mm	1 Adet



ABDOMİNAL / VASKÜLER EKARTÖRLER

ABDOMINAL / VASCULAR RETRACTORS



DEAVER

Kod:	Açıklama:
10.761	25x125 mm
10.762	40x125 mm
10.763	50x125 mm
10.764	60x125 mm
10.765	80x125 mm



HARRINGTON

Kod:	Açıklama:
10.766	40x125 mm
10.767	65x100 mm
10.768	65x150 mm
10.769	65x200 mm
10.770	65x250 mm



Kod:	Açıklama:
10.771	25x140 mm
10.772	25x200 mm

Damar Ekartörü / Bükülebilir
Vascular retractor flexible



Bükülebilir
Flexible

Kod:	Açıklama:
10.773	13x65mm
10.774	13x90mm
10.775	13x150mm
10.776	13x200mm
10.777	25x100mm
10.778	25x110mm
10.779	25x130mm
10.780	25x200mm
10.781	25x250mm
10.782	40x200mm
10.783	40x250mm
10.784	50x100mm
10.785	50x200mm
10.786	50x250mm
10.787	65x250mm
10.788	75x250mm
10.789	100x250mm
10.790	65x150mm



Kod:	Açıklama:
10.791	150 mm

Bükülebilir
Flexible



Kod:	Açıklama:
10.793	25x140 mm
10.794	25x200 mm

Damar ekartörü
Vascular retractor

ABDOMİNAL / VASKÜLER / JİNEKOLOJİ / KOLON EKARTÖR BLEYTLER

ABDOMINAL / VASCULAR / GYNECOLOGY / COLON RETRACTORS



BALFOUR

Kod:	Açıklama:
10.795	30x30 mm
10.796	50x30 mm
10.797	50x60 mm
10.798	70x50 mm
10.799	70x75 mm
10.800	80x60 mm
10.801	80x75 mm
10.802	80x125 mm
10.803	90x150 mm
10.804	100x60 mm



BALFOUR

Kod:	Açıklama:
10.818	90 mm
10.819	130 mm



RICHARDSON

Kod:	Açıklama:
10.805	50x75 mm
10.806	50x100 mm
10.807	50x125 mm
10.808	50x150 mm
10.809	50x170 mm



RICHARDSON

Kod:	Açıklama:
10.820	20x25 mm
10.821	20x50 mm
10.822	25x30 mm
10.823	45x50 mm



FENCE

Kod:	Açıklama:
10.810	50x110 mm
10.811	50x150 mm
10.812	100x100 mm
10.813	100x125 mm
10.814	100x150 mm
10.815	100x200 mm



KELLY

Kod:	Açıklama:
10.824	40x50 mm
10.825	50x60 mm
10.826	60x70 mm
10.827	80x90 mm



ST.MARKS

Kod:	Açıklama:
10.816	65x140 mm
10.817	65x180 mm

Pelvis ekartörü
Pelvis retractor



HEANY

Kod:	Açıklama:
10.826	25x100 mm
10.827	25x130 mm

ABDOMİNAL / REKTAL / UROLOJİ EKARTÖR BLEYTLER

ABDOMİNAL / RECTAL / URULOGY / RETCACTOR BLADES



Kod: **Açıklama:**
10.828 13x70 mm
10.829 13x75 mm
10.830 25x65 mm
10.831 25x75 mm
Mesane ekartörü
Bladder retractor



Kod: **Açıklama:**
10.840 25x65 mm
Mesane ekartörü
Bladder retractor



Kod: **Açıklama:**
10.832 80x130 mm



HOLTGREWE

Kod: **Açıklama:**
10.841 60x150 mm



MURPHY

Kod: **Açıklama:**
10.834 19x13 mm Sivri/Sharp
10.835 19x13 mm Künt/Blunt
10.836 25x13 mm Sivri/Sharp
10.837 25x13 mm Künt/Blunt

Cilt ekartörü
Skin retractor



VOLKMAN

Kod: **Açıklama:**
10.842 16x13 mm Sivri/Sharp
10.843 16x13 mm Künt/Blunt
10.844 25x13 mm Sivri/Sharp
10.845 25x13 mm Künt/Blunt

Cilt ekartörü
Skin retractor



HILL-FERGUSON

Kod: **Açıklama:**
10.838 25x65 mm
10.839 30x75 mm
Rektum ekartörü
Rectum retractor

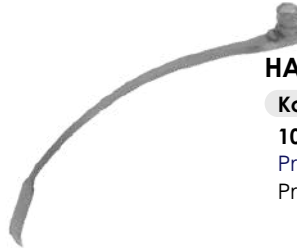

HARRIS

Kod: **Açıklama:**
10.846 -
Prostat ekartörü
Prostate retractor

SPİNAL / SERVİKAL / LUMBAR EKARTÖR BLEYTLER

SPINAL / CERVICAL / LUMBAR RETRACTOR BLADES



MEYERDING

Kod:	Açıklama:
10.847	16x50 mm
10.848	16x75 mm
10.849	16x100 mm
10.850	25x50 mm
10.851	25x75 mm
10.852	25x100 mm



MEYERDING

Kod:	Açıklama:
10.872	16x50 mm
10.873	16x75 mm
10.874	16x100 mm
10.875	25x50 mm
10.876	25x75 mm
10.877	25x100 mm



MEYERDING

Kod:	Açıklama:
10.853	16x40 mm
10.854	16x45 mm
10.855	16x50 mm
10.856	16x55 mm
10.857	16x60 mm



MEYERDING

Kod:	Açıklama:
10.878	20x80 mm
10.879	45x80 mm
10.880	60x80 mm
10.881	20x100 mm
10.882	45x100 mm
10.883	60x100 mm
10.884	20x120 mm
10.885	45x120 mm
10.886	60x120 mm



MEYERDING

Kod:	Açıklama:
10.858	16x40 mm
10.859	16x45 mm
10.860	16x50 mm
10.861	16x55 mm
10.862	16x60 mm



SCOVILLE

Kod:	Açıklama:
10.887	75 mm
10.888	100 mm



Kod:	Açıklama:
10.863	20x55mm
10.864	25x30mm
10.865	25x40mm
10.866	25x50mm
10.867	25x60mm
10.868	25x70mm
10.869	25x80mm

Lumbar ekartör / Eğri uçlu
Lumbar retractor / Curved



Kod:	Açıklama:
10.889	13x50mm
10.890	13x75mm
10.891	13x100mm
10.892	19x50mm
10.893	19x75mm
10.894	19x100mm
10.895	50x25mm
10.896	75x25mm
10.897	25x100mm

Lumbar ekartör / Düz uçlu
Lumbar retractor / Straight



Root ekartörü
Root retractor

Kod:	Açıklama:
10.870	90



Root ekartörü
Root retractor

Kod:	Açıklama:
10.871	45



Kod:	Açıklama:
10.898	25x100mm
10.899	25x150mm
10.900	25x200mm
10.901	25x250mm
10.902	30x100mm
10.903	30x150mm
10.904	30x200mm
10.905	30x250mm

Anterior lumbar ekartör / Tırnaklı
Anterior lumbar retractor / With nail

THOMSON SETİ

THOMSON SET

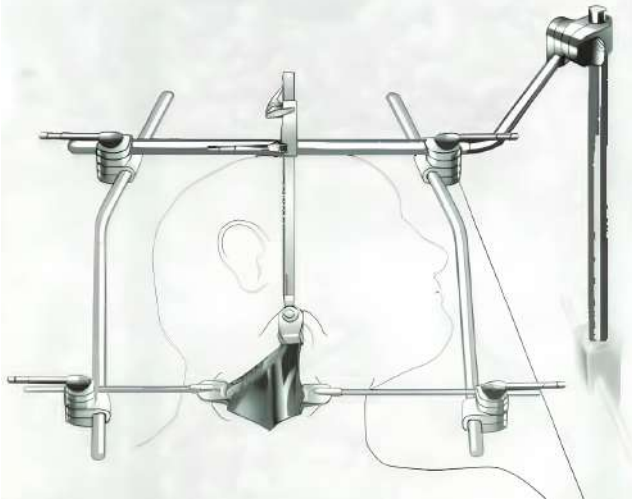

10-1450
Carodio retractor set
10-1500, 10-1521, 10-1523 x2, 10-1571 x2, 10-1590, 10-1582,
10-1700, 10-1896 x2



10-1451
Anterior cervical retractor set
10-1500, 10-1521, 10-1523 x2, 10-1571 x5, 10-1581, 10-1628,
10-1755 x3, 10-1742

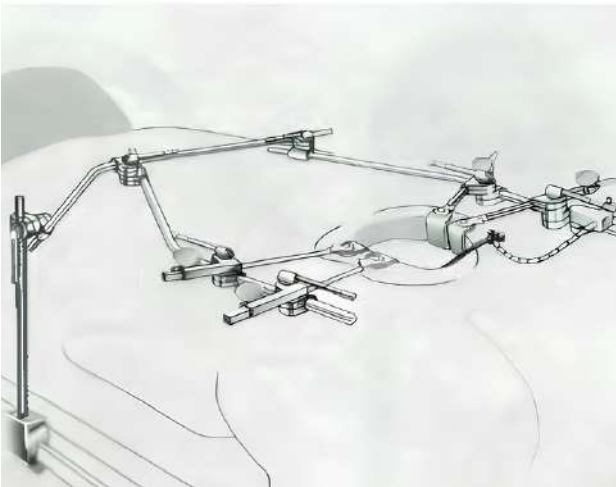

10-1452
Multi-Level posterior set
10-1500, 10-1521, 10-1523 x2, 10-1590 x4, 10-1582 x4,
10-1797, 10-1595, 10-1832

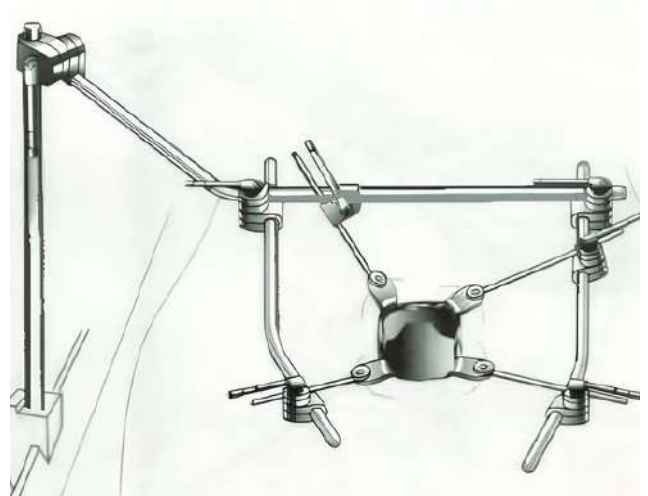

10-1453
Mini incision urology set includes
10-1500, 10-1521, 10-1523 x2, 10-1571 x4, 10-1580 x4,
10-1846 x4

THOMSON SETİ

THOMSON SET

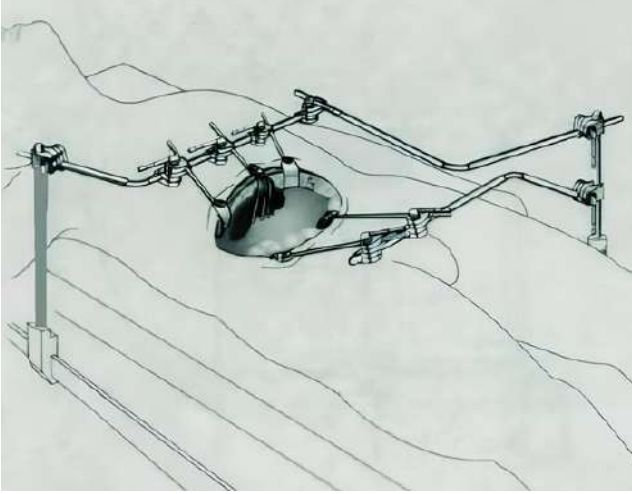

10-1457

Liver transplant set includes

**10-1500, 10-1501, 10-1520, 10-1523 x 2, 10-1571 x5
10-1581 x5, 10-1600, 10-1625 x4**

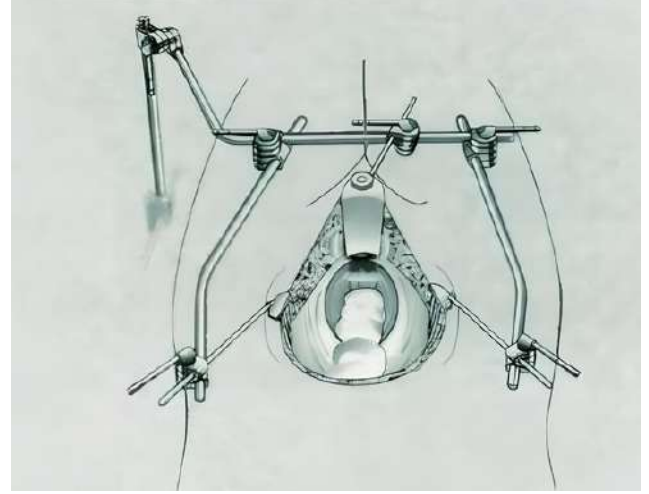

10-1458

Colon-Rectal retractor set

**10-1500, 10-1521, 10-1523 x2, 10-1571 x3, 10-1691 x2,
10-1580 x5, 10-1848**

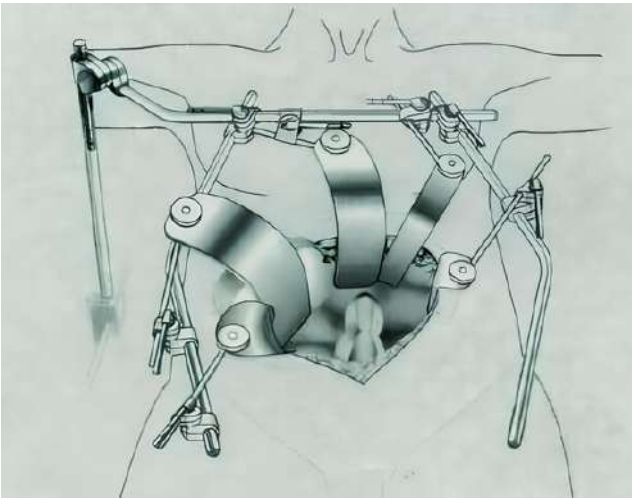

10-1459

General-vascular retractor set

**10-1500, 10-1521, 10-1523 x2, 10-1571 x5, 10-1580 x5,
10-1852, 10-1846, 10-1859, 10-1857, 10-1854**

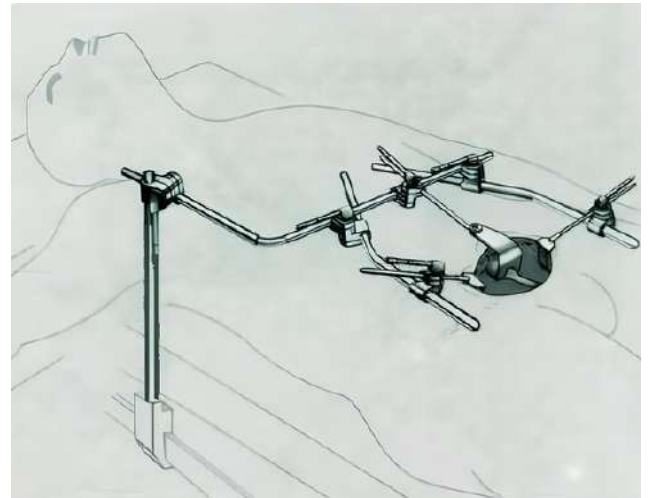

10-1460

Abdominal urology retractor set (For retropubic prostatectomy)
includes

**10-1500, 10-1521, 10-1523 x2, 10-1571 x3, 10-1691 x2, 10-1580,
10-1874**

THOMSON SETİ

THOMSON SET

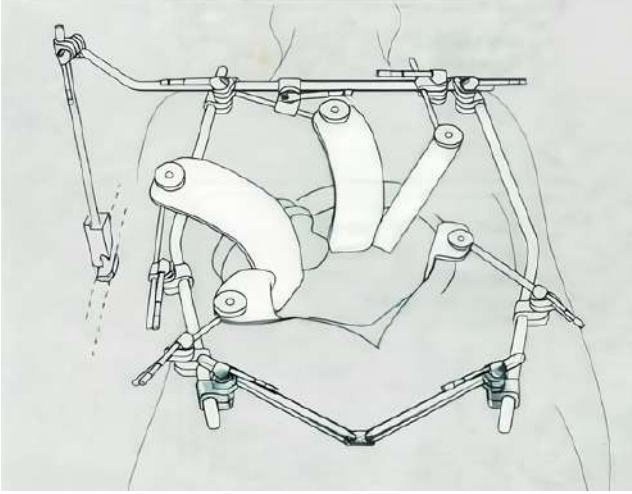

10-1461

Accessory frame set includes

10-1500, 10-1521, 10-1523 x2, 10-1571 x5, 10-1580 x5, 10-1852, 10-1846, 10-1859, 10-1857, 10-1854, 10-1560, 10-1570 x2

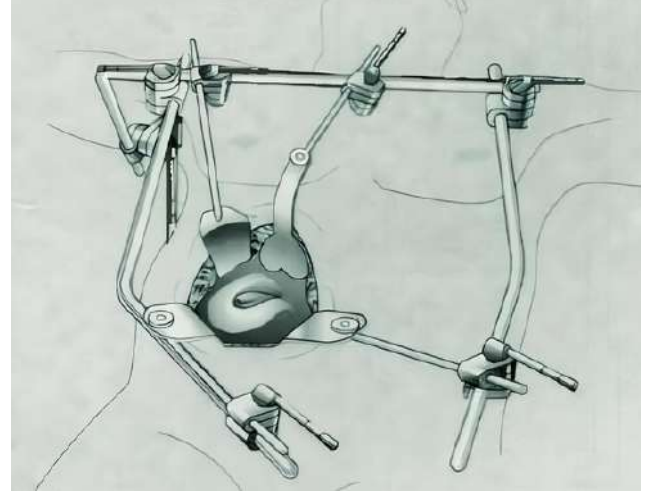

10-1462

General retractor set includes

10-1500, 10-1551, 10-1570 x2, 10-1571 x4, 10-1643, 10-1580 x3, 10-1877, 10-1868 x2

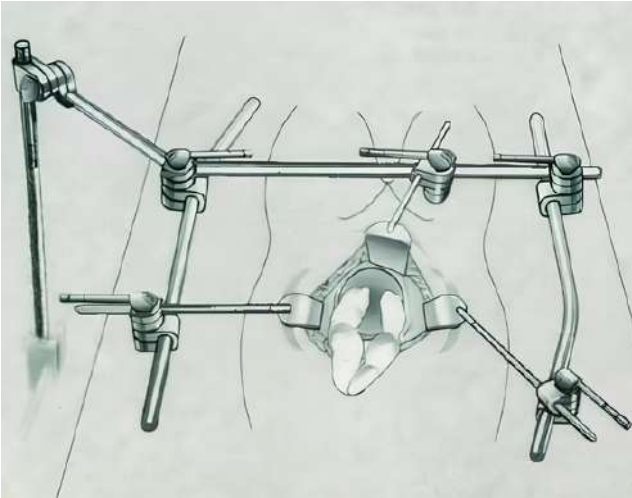

10-1463

Pediatric retractor set

10-1500, 10-1521, 10-1523 x2, 10-1571 x3, 10-1643, 10-1661 x2

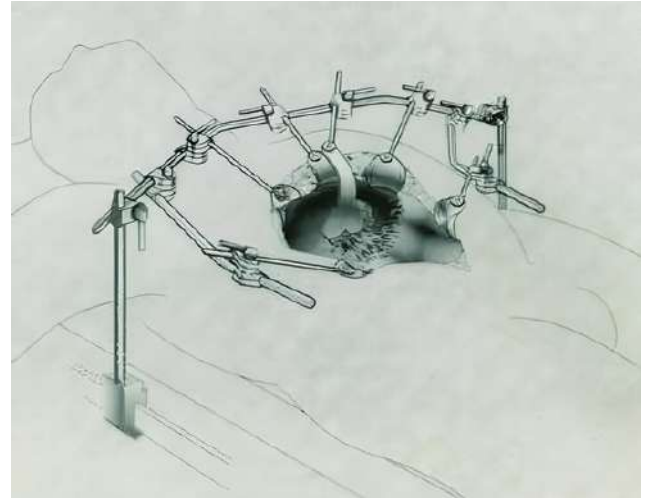

10-1464

Obesity blade set includes

10-1500 x2, 10-1522, 10-1523 x2, 10-1571 x6, 10-1580 x6, 10-1851 x4, 10-1853, 10-1877

THOMSON SETİ

THOMSON SET

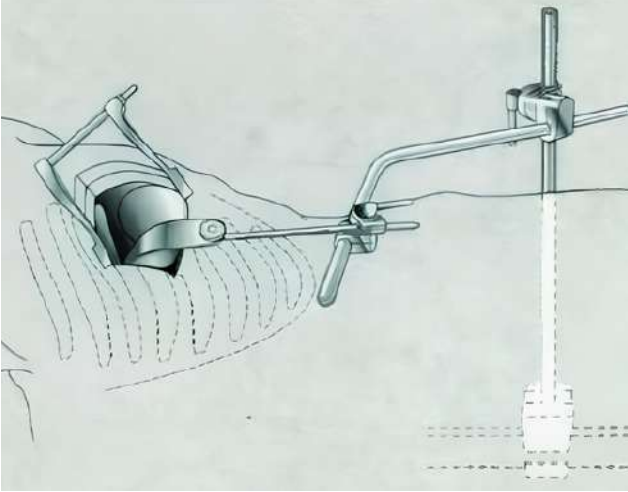

10-1457

Liver transplant set includes
**10-1500, 10-1501, 10-1520, 10-1523 x2, 10-1571 x5, 10-1581 x5,
10-1600, 10-1625 x4**

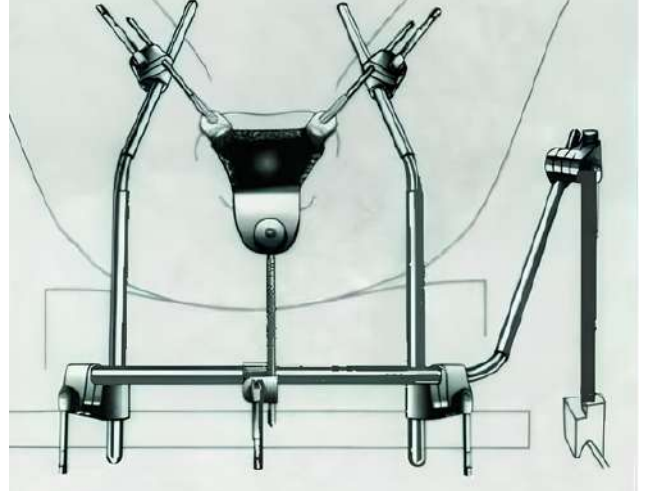

10-1458

Colon-Rectal retractor set
**10-1500, 10-1521, 10-1523 x2 , 10-1571 x3 , 10-1691 x2 ,
10-1580 x5 , 10-1848**

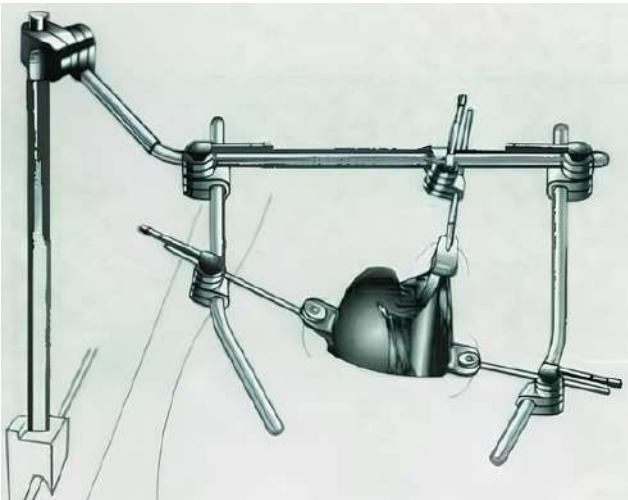

10-1459

General-vascular retractor set
**10-1500, 10-1521, 10-1523 x2 , 10-1571 x5, 10-1580 x5,
10-1852, 10-1846, 10-1859, 10-1857, 10-1854**

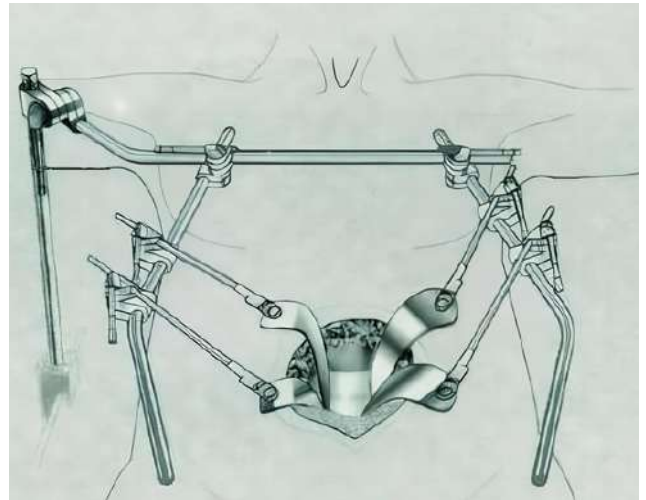

10-1460

Abdominal urology retractor set (For retropubic
prostatectomy) includes
**10-1500, 10-1521, 10-1523 x2 , 10-1571 x3, 10-1691 x2,
10-1580, 10-1874**

Masa Bağlantı Direği
48 cm
58 cm

10.482



2.5 cm

Çember Tutucu
36.5 cm

10.483



Çember Tutucu , hareketli
360°

10.500



Yatay çubuk
30.5 cm

10.501



Bağlantı Elemanı

10.484



Ekartör uzatma kolu

10.540



Ekartör bağlantı elemanı
Dönebilir
10.539



Ekartör bağlantı elemanı
Sabit
10.486



Ekartör bağlantı elemanı
Değişebilir açılı
10.487



Küçük Ø 215 mm **10.503**
Orta Ø 265 mm **10.504**
Büyük Ø 315 mm **10.505**
Yuvarlak çember

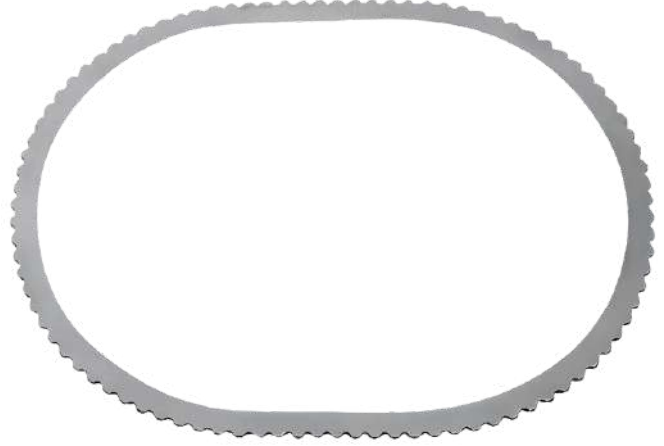

Küçük Ø 200 x 310 mm **10.490**
Orta Ø 265 x 370 mm **10.491**
Büyük Ø 265 x 470 mm **10.492**
Yuvarlak çember

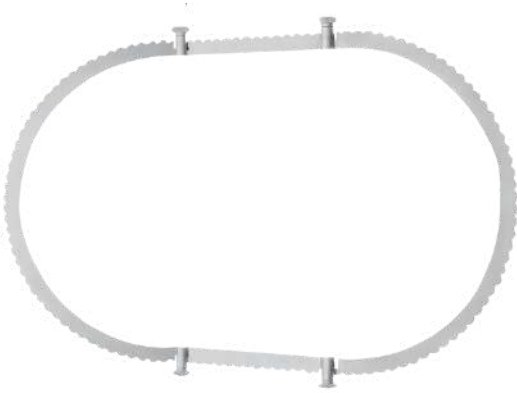

Ø 215 x 355 mm **10.509**
Ø 265 x 495 mm **10.510**
Ø 405 x 595 mm **10.511**
Parçalı oval çember

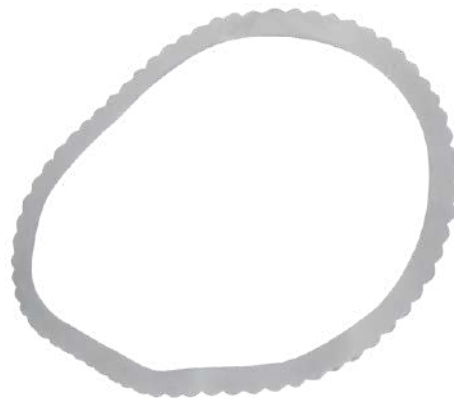

200 x 265 mm **10.502**
Oval Çember

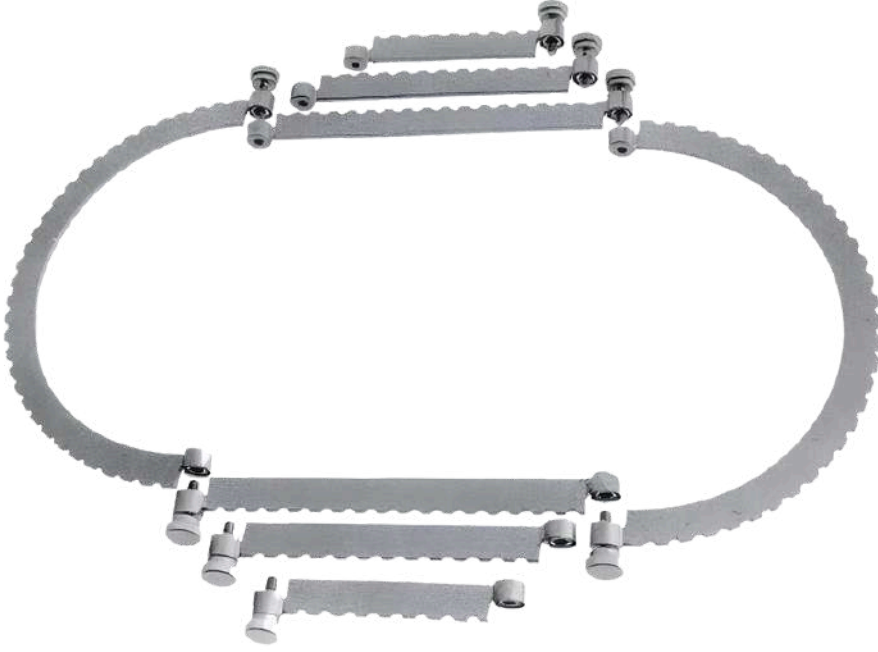

Spinal Cerrahi Ekartörü

Yarım çember	203 mm 2 adet	10.200
Ekleme parçası	101 mm 2 adet	10.201
Ekleme parçası	152 mm 2 adet	10.202
Ekleme parçası	203 mm 2 adet	10.203



400 x 460 mm
Ayarlanabilir çember **10.204**



310 x 460 mm
Ayarlanabilir çember **10.205**



MEYERDING
17 x 60 mm **10.217**
25 x 85 mm **10.218**
50 x 95 mm **10.219**

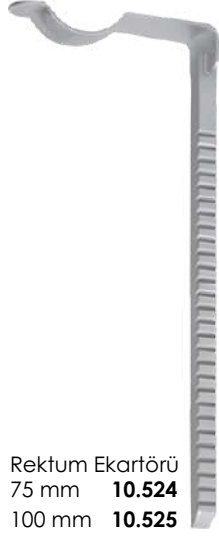

Rektum Ekartörü
75 mm **10.524**
100 mm **10.525**



RICHARDSON
20 x 25 mm **10.220**
20 x 50 mm **10.221**
25 x 30 mm **10.222**



MAYO
30 x 30 mm **10.223**
50 x 50 mm **10.224**

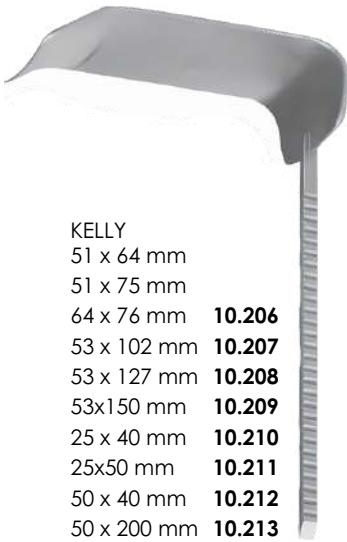

KELLY
51 x 64 mm
51 x 75 mm
64 x 76 mm **10.206**
53 x 102 mm **10.207**
53 x 127 mm **10.208**
53x150 mm **10.209**
25 x 40 mm **10.210**
25x50 mm **10.211**
50 x 40 mm **10.212**
50 x 200 mm **10.213**



Aposteriori Ekartör
25 x 115 mm **10.214**



Vajinal Yan Ekartör
25 x 75 mm **10.215**

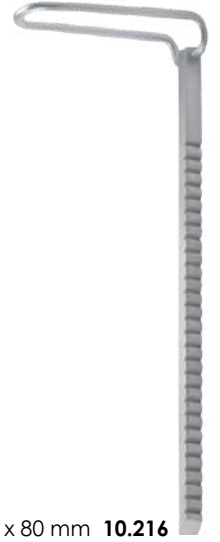

30 x 80 mm **10.216**

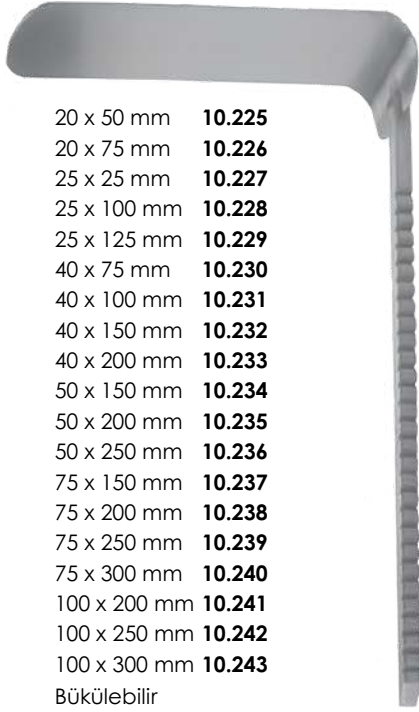



BALFOUR
75 x 60 mm **10.257**
75 x 80 mm **10.258**
75 x 90 mm **10.259**



BALFOUR
65 x 75 mm **10.481**



HARRINGTON
40 x 145 mm **10.488**
65 x 145 mm **10.489**
60 x 140 mm **10.490**
90 x 250 mm **10.491**
110x 250 mm **10.492**



ST. MARKS
60 x 190 mm **10.260**



DEAVER
25 x 110 mm **10.261**
40 x 110 mm **10.262**
50 x 110 mm **10.263**



MARGINA
25 x 90 mm **10.512**
25 x 130 mm **10.513**



BOOKWALTER
17 x 20mm
10.519



BOOKWALTER
20 x 8.5mm
10.520

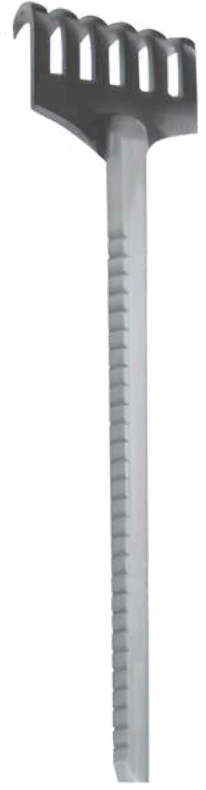

BOOKWALTER
20 x 8.5mm
10.521



85mm

SCOVILLE-BOOKWALTER
10.523

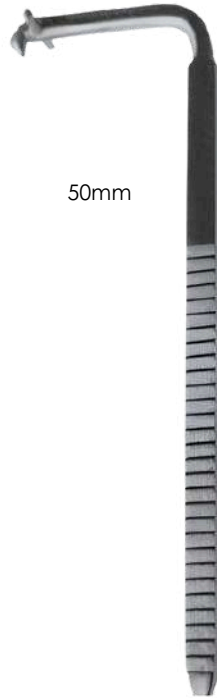

50mm

SCOVILLE-BOOKWALTER
10.522



BOOKWALTER-GELPI
10.529

Kaşık boyu
Length of spatula
10 cm



09.386 8 mm	09.321 14 mm
09.387 11 mm	09.322 17 mm
09.388 14 mm	09.323 20 mm
09.389 17 mm	
Bükülebilir Malleable 15.5 cm	Bükülebilir Malleable 20 cm

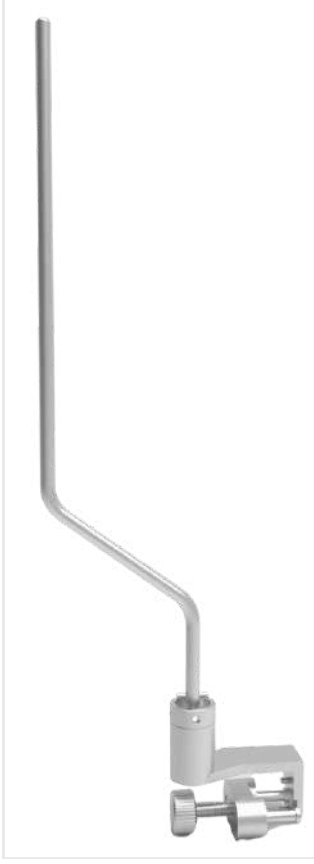

19.111

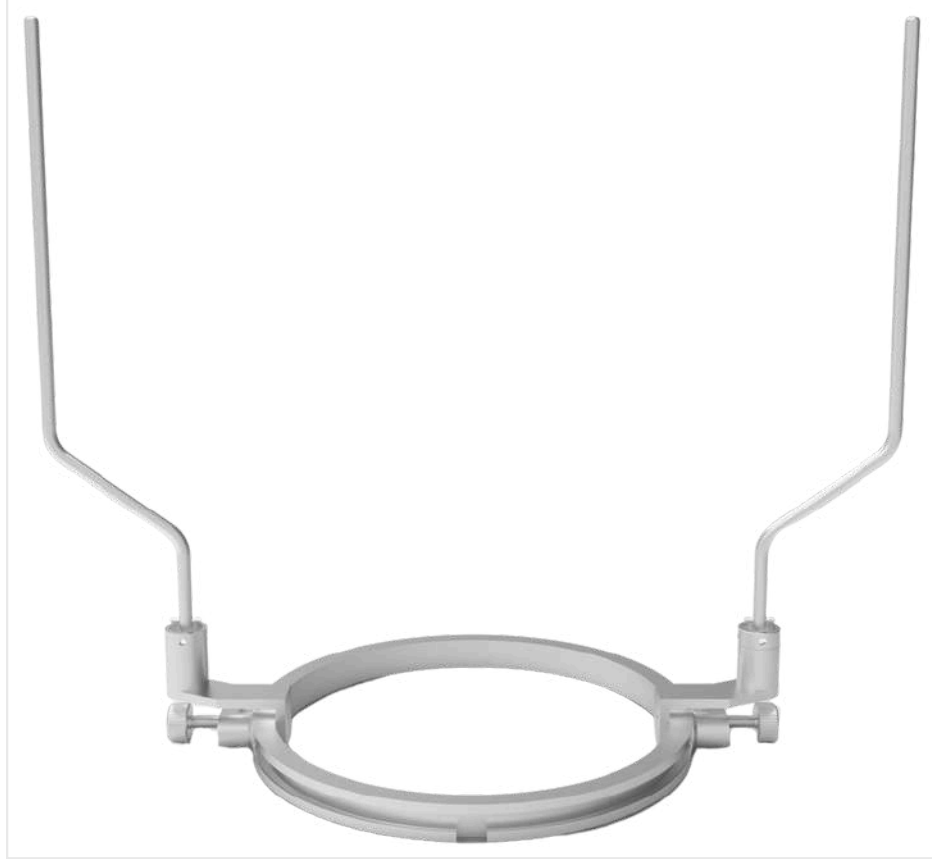

19.110



19.114



19.008



19.112

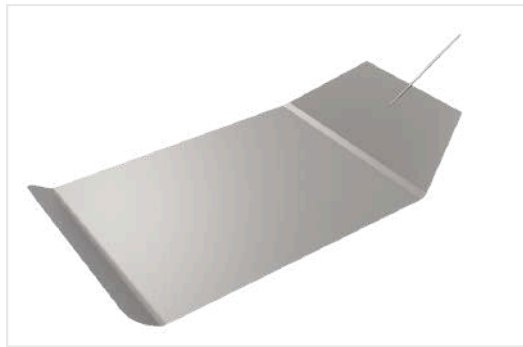

19.113



Holo Sistemli Çivili Başlık Seti



Factory
Şabanoğlu OSB Mah. Cumhuriyet Caddesi No: 6/1
Tekkeköy
SAMSUN / TÜRKİYE

+90 362 266 4161
+90 362 266 7277
www.uzmancerrahi.com
info@uzmancerrahi.com

All rights reserved. No visual and text in this catalog can be used without the written permission of Uzman Cerrahi Aletler.